



# FLOW MONO

(EasyHopper)

( Art : 260 - 000 x x )

## Status

<input type="checkbox"/> Aanvraag	<input type="checkbox"/> Bestelling
<input type="checkbox"/> Zicht	

Datum

## Gegevens Dealer

Dealer	
Adres	
Pc/ Woonplaats	
Contactpersoon	
E-mail	
Tel	
Fax	

## Afleveradres

Dealer	
Adres	
Pc/ Woonplaats	
Contactpersoon	



## Gegevens gebruiker

Voor- en achternaam	
Leeftijd	
Gewicht	
1) Lichaamslengte staand - cm	
2) Heupbreedte zittend - cm	
3) Bovenbeenlengte - cm	
4) Onderbeenlengte - cm	
5) Ellebooghoogte - cm	

**Belangrijk volledig invullen!**

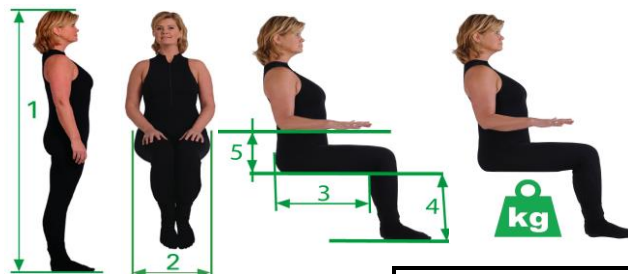

## Gewenste instelling

Zithoogte voor (F) - cm		Standaard = 53
Zithoogte achter (G) - cm		Standaard = 49
Wielbalans / Zwaartepunt (W) - cm		Standaard = 8

**Basisprijs**

€

**2.819**

Alle prijzen excl. Btw.

## Advies en Aflevering

Passing en advies op locatie inclusief aflevering en instellen	<input type="checkbox"/>	€ 746
Passing en advies op locatie	<input type="checkbox"/>	€ 373
Passing en advies bij O4 Wheelchairs	<input type="checkbox"/>	€ 0

## Gegevens van de rolstoel

### Aanpassingen

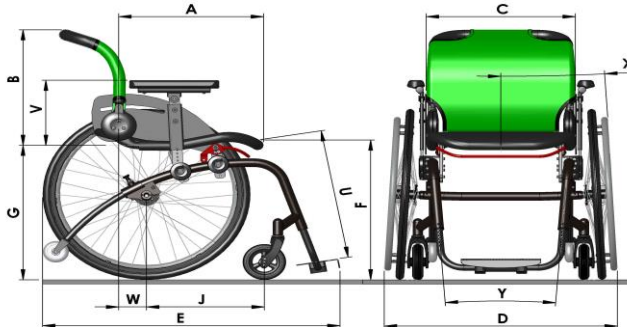
Meerprijs opties	€
Meerprijs aanpassingen	€
<b>Totale verkoop prijs</b>	€
Verpakkings- en transportkosten	€ 70,-

De Flow Mono is niet geschikt voor gebruik met o.a. handbike, freewheel of andere externe hulpmiddelen. Voorbereiding t.b.v. taxifixatie is ook niet mogelijk.

## Uitvoering

<input type="checkbox"/>		<input type="checkbox"/>	
	<b>Original</b> Wighoek niet instelbaar Rughoek vast i.c.m. basis rugversteller of instelbaar i.c.m. RCA 1.0 of 1.5 Voor een actieve zithouding		<b>Active (WorkHopper)</b> Wighoek en rughoek instelbaar alleen i.c.m. RCA 1.0 of RCA 1.5 Voor een actieve zithouding
	<b>Standaard</b>		<b>€ 1.569</b>
			<b>Art : 131-000 X X</b>

## Afneembare zitunit

	
<b>Afneembare zitunit</b> *alleen mogelijk i.c.m. original uitvoering	
<b>€ 586</b>	
<b>Art : 800-40129</b>	

## Zitbreedte (C)

<input type="checkbox"/>	34cm	<input type="checkbox"/>	36,5cm	<input type="checkbox"/>	39cm	<input type="checkbox"/>	41,5cm	<input type="checkbox"/>	44cm	<input type="checkbox"/>	46,5cm
	Standaard		Standaard		Standaard		Standaard		Standaard		Standaard
	<b>Art : 800-40134</b>		<b>Art : 800-40136</b>		<b>Art : 800-40139</b>		<b>Art : 800-40141</b>		<b>Art : 800-40144</b>		<b>Art : 800-40146</b>
<input type="checkbox"/>	29cm	<input type="checkbox"/>	31,5cm								
	Op aanvraag		Op aanvraag								
	<b>Art : 800-40129</b>		<b>Art : 800-40131</b>								

## Framevorm (Y)

<input type="checkbox"/>		<input type="checkbox"/>		<input type="checkbox"/>	
	<b>U-vorm</b>		<b>V8</b>		<b>Abductie</b>
	Standaard		€ 208		€ 421
	Voetruimte = zitbreedte - 10 cm		Leverbaar vanaf zitbreedte 39cm Voetruimte = zitbreedte - 15cm		Voetruimte = zitbreedte - 5cm
	<b>Art : 800-40210</b>		<b>Art : 800-40220</b>		<b>Art : 800-40200</b>

## Framelengte (J)

<input type="checkbox"/>	34cm	<input type="checkbox"/>	40cm	<input type="checkbox"/>	45cm
	Aanbevolen zitdiepte 37,5 - 42,5cm		Aanbevolen zitdiepte 42,5 - 50cm		Aanbevolen zitdiepte 45 - 50cm
	<b>Art : 800-40034</b>		<b>Art : 800-40040</b>		<b>Art : 800-40045</b>

## Framekleur

<input type="checkbox"/>	Zwart Mat RAL 9005	<input type="checkbox"/>	Speciaal - Uni
	Standaard		€ 277
			Gewenste RAL-kleur aangeven via <a href="http://www.ralkleuren.com">www.ralkleuren.com</a>
	<b>Art : 800-40340</b>		<b>Art : 800-40350</b>

## Camberhoek (X)

<input type="checkbox"/> 0°	<input type="checkbox"/> 3°	<input type="checkbox"/> 6°
Standaard	€ 54	€ 80
Art : 800-40400	Art : 800-40403	Art : 800-40406

## Voetsteun (U)

Onderbeenlengte instelbaar (bij laagste zithoogte voor van 47 cm met 24 inch aandrijfwielen)			
<input type="checkbox"/>	<input type="checkbox"/>	<input type="checkbox"/>	
Gebogen	Rechthoekig	Opklapbaar 1 delig	
Onderbeenlengte 39 - 44cm	Onderbeenlengte 33 - 38cm	Onderbeenlengte 33 - 44cm	
		Voetruimte : minimaal 24cm U-vorm : vanaf zitbreedte 39cm V8 : vanaf zitbreedte 44cm	
Standaard	Standaard	€ 250	
Art : 200 - 38100	Art : 200 - 38200	Art : 200 - 38300	



## Voetplaat

<input type="checkbox"/>	<input type="checkbox"/>	<input type="checkbox"/>	<input type="checkbox"/> Maatwerk	<input type="checkbox"/> Maatwerk
Standaard ( 23 x 12cm ) Aluminium	Breed ( 29 x 12cm ) Aluminium	Diep ( 23 x 19cm ) Aluminium	Aluminium	Kunststof
	U-vorm: vanaf zitbreedte 39cm V8: vanaf zitbreedte 44cm		In opdracht na tekening	
Standaard	€ 102	€ 102	Op aanvraag	
Art : 800 - 38009	Art : 800 - 38010	Art : 800 - 38040	Art : 800 - 3801 x	Art : 800 - 3802 x



## Zitdiepte (A)

<input type="checkbox"/> 37,5cm	<input type="checkbox"/> 40cm	<input type="checkbox"/> 42,5cm	<input type="checkbox"/> 45cm	<input type="checkbox"/> 47,5cm	<input type="checkbox"/> 50cm
					Niet met RCA1.5
Art : 800-40537	Art : 800-40540	Art : 800-40542	Art : 800-40545	Art : 800-40547	Art : 800-40550

## Zitting

<input type="checkbox"/>	<input type="checkbox"/>
	
Zitting vlak met Seat-E-Lastica; niet in combinatie met RCA 1.0	Zitting contour ergonomisch, gestoffeerd
€ 373	€ 628
Art : 100-142 x x	Art : 100-122 x x



## Rugversteller

<input type="checkbox"/>	<input type="checkbox"/>	<input type="checkbox"/>
		
Basis	RCA 1.0	RCA 1,5 i.c.m. extern kussen
Rug neerklapbaar en rughoek mechanisch instelbaar	Rugversteller gecentreerd.	Rugversteller 2,5 cm teruggezet
(Verstelbereik 85° - 115°)	Permanent verstelbaar door gebruiker in stappen van 3° (Verstelbereik 0 - 85 - 115°) RCA = Remote Continuous Adjustable	
Standaard	€ 984	€ 984
Art : 100-38000	Art : 100-32000	Art : 100-36000



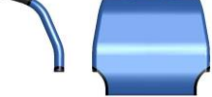

## Positie Rugversteller

Positie RCA Bediening Rugversteller	
<input type="checkbox"/>	<input type="checkbox"/>
Links op het frame	Rechts op het frame
Art : 100-51030	Art : 100-51040





## Rugvorm

<input type="checkbox"/>	<input type="checkbox"/>	<input type="checkbox"/>
		
Vorm recht	Ergonomisch, anatomisch vanaf rughoogte 40 cm	Rugleuning voor vrouwen, ergonomisch, anatomisch vanaf rughoogte 40 cm
Standaard	€ 474	€ 612
Art : 100-225 x x	Art : 100-200 x x	Art : 100-220 x x

## Rughoogte (B)

<input type="checkbox"/>	<input type="checkbox"/>	<input type="checkbox"/>	<input type="checkbox"/>
			
Hoogte 35cm	Hoogte 40cm	Hoogte 45cm	Hoogte 50cm
Art : 800-42135	Art : 800-42140	Art : 800-42145	Art : 800-42150

## Kleur rughoes



<input type="checkbox"/>	<input type="checkbox"/>	<input type="checkbox"/>	<input type="checkbox"/>	<input type="checkbox"/>	<input type="checkbox"/>
					Reservehoes rugleuning
Rood	Zwart	Donkerblauw	Geel	Blauwgroen	Kleur:
Standaard	Standaard	Standaard	Standaard	Standaard	€ 102
Art : 100-401 x x	Art : 100-402 x x	Art : 100-405 x x	Art : 100-407 x x	Art : 100-408 x x	Art : 100-40x x x

## Wieldiameter

Mogelijke zithoogte zie maatblad

<input type="checkbox"/>	<input type="checkbox"/>	<input type="checkbox"/>
24" + 1 - ( 25-540 )	25"	26" + 2 - ( 25 - 590 )
Standaard	€ 128	€ 128
Art : 800-41024	Art : 800-41025	Art : 800-41026





## Aandrijfwiel (set, met Quick Release)

<input type="checkbox"/>	<input type="checkbox"/>	<input type="checkbox"/>
		Lichtgewicht Spinerwheels - Set
	Trommelrem (set) Incl. Frame-aanpassing. Standaard met zwarte aluminium hoepels, alleen in 24 " leverbaar. Duwbeugel sterk aanbevolen	
Standaard	€ 1.197	Op aanvraag
Art : 800-41024	Art : 991 - 42 x x x	Art : 991 - 43 x x x

## Eénhandaandrijving

<input type="checkbox"/>	<input type="checkbox"/>
Aandrijving Links	Aandrijving Rechts
	
Eénhandaandrijving (Hemi) - zithoogte wordt 2 cm hoger (voor en achter) niet mogelijk met 6° - 9° camber, alleen in 24"	
€ 1.772	
Art : 991 - 41 x x x	

## Achterband



<input type="checkbox"/>	<input type="checkbox"/>	<input type="checkbox"/>	<input type="checkbox"/>	<input type="checkbox"/>
				
Schwalbe Marathon Plus Evolution - of vergelijkbare kwaliteit	Massief - PU	Schwalbe Right Run Rood	Schwalbe Right Run Blauw	Schwalbe Right Run Grijs
Standaard	€ 91	€ 0	€ 0	€ 0
Art : 991-67 x 01	Art : 991-67 x 11	Art : 991-67 X 21	Art : 991-67 X 22	Art : 991-67 X 23

<input type="checkbox"/>	Elektrische wielnaaf aandrijving / ondersteuning(Alber)	
<input type="checkbox"/>	E-Fix E35	<input type="checkbox"/> E-Motion
Alber-aandrijving is technisch mogelijk, aanbevolen frame aanpassing - € 112		
Levering wielset via dealer		



## Hoepel (paar)



<input type="checkbox"/>	<input type="checkbox"/>	<input type="checkbox"/>	<input type="checkbox"/>	<input type="checkbox"/>	CarboLife	
Aluminium	TETRA	PARA	ERGO	Roestvrijstaal	<input type="checkbox"/>	<input type="checkbox"/>
Standaard	€ 458	€ 458	€ 500	€ 261	€ 266,00	€ 266,00
	Gripversterkende hoepels	Gripversterkende hoepels	Gripversterkende hoepels			
Art : 800-62x11	Art : 800-62x01	Art : 800-62x02	Art : 800-62x03	Art : 800-62x12	Art : 991 : 624xx	Art : 991 : 624xx

## Wiel accessoire (paar)

Set <input type="checkbox"/>		Set <input type="checkbox"/>	
Spaakbeschermer transparant		Spaakbeschermer transparant met O4-opdruk	
€ 208		€ 187	
Art : 991 - 60 x 01		Art : 991 - 60 x 02	

## Rem

<input type="checkbox"/>	Links	Rechts	<input type="checkbox"/>	<input type="checkbox"/>	Links	Rechts	<input type="checkbox"/>	<input type="checkbox"/>	Links	Rechts	<input type="checkbox"/>
											
Trekrem (trekken om te remmen)		Drukrem (drukken om te remmen)		Actiefrem							
Standaard		Standaard		€ 165	€ 165						
Art : 800-47103	Art : 800-47203	Art : 800-47104	Art : 800-47204	Art : 800-47106	Art : 800-47206						

<input type="checkbox"/>	Links	Rechts	<input type="checkbox"/>
			
Lange drukrem, neerklapbaar (drukken om te remmen)			
€ 80		€ 80	
Art : 800 - 07105		Art : 800 - 07205	

<input type="checkbox"/>	Links	Rechts	<input type="checkbox"/>
			
Éénhandrem (drukken om te remmen)			
€ 399			
Art : 800-47110			

## Voorwiel (Set)



Mogelijkheden i.v.m. zithoogtes zie technisch maatblad

<input type="checkbox"/>		<input type="checkbox"/>		<input type="checkbox"/>	
Soft 4" Kunststof		Hard 4" Kunststof		Hard 4" Aluminium	
€ 59		€ 70		€ 155	
Art : 800 - 04001		Art : 800 - 04002		Art : 800 - 04003	



<input type="checkbox"/>		<input type="checkbox"/>		<input type="checkbox"/>	
Soft 5" Kunststof		Hard 5" Kunststof		Hard 5" Aluminium	
Standaard		€ 70		€ 155	
Art : 800 - 05001		Art : 800 - 05002		Art : 800 - 05003	

<input type="checkbox"/>	
Soft 6" Kunststof	
€ 59	
Art : 800 - 06001	



## Antikiep

<input type="checkbox"/> Links  Rechts <input type="checkbox"/>	<input type="checkbox"/> Links  Rechts <input type="checkbox"/>	<input type="checkbox"/> Links  Rechts <input type="checkbox"/>
<b>Antikiep</b> Telescopisch in hoogte verstelbaar	<b>Trappijp - vast</b> (niet in combinatie met antikiep set)	<b>Stokhouder</b>
€ 165	€ 165	€ 112
Art : 800 - 44000	Art : 800 - 45000	Art : 800-43010



## Zijschild

<input type="checkbox"/> Set 	<input type="checkbox"/> Set 	<input type="checkbox"/> Set 	<input type="checkbox"/>
Zijschild afneembaar zonder spatrand, alleen in combinatie met armleuning	Zijschild vast, zonder spatrand, aluminium	Zijschild vast met spatrand, carbon	Gaten maken in Zijschild vast met spatrand, Carbon *Verplicht in combinatie met armleggers
€ 133	€ 133	€ 399	€ 123
Art : 100 - 96030	Art : 100 - 96040	Art : 100 - 96010	Art : 100 - 96061

## Armsteunen





<input type="checkbox"/> Set 	<input type="checkbox"/> Set 
In hoogte verstelbare armsteun, afneembaar, vaste hoek met standaard polstering. Montage bij zijschild met spatrand worden de zijschilden aangepast (alléén carbon, meerprijs).	In hoogte verstelbare armsteun, afneembaar, hoekinstelbaar met standaard polstering. Voor montage bij zijschild met spatrand worden de zijschilden aangepast (alléén carbon, meerprijs).
€ 399	€ 511
Art : 100 - 96110	Art : 100 - 96170



## Armpolstering

<input type="checkbox"/> Links  Rechts <input type="checkbox"/>	<input type="checkbox"/> Links  Rechts <input type="checkbox"/>	<input type="checkbox"/> Links  Rechts <input type="checkbox"/>
Hemiplegie-armpolstering (Per stuk)	Armpolstering lang 36 x 5,5cm 10cm langer als standaard (Per stuk)	Maatwerk
€ 250	€ 250	Op aanvraag
Art : 100 - 96140	Art : 100 - 96240	Art : 100 - 96130

## Accessoires

<input type="checkbox"/> 	<input type="checkbox"/> 	<input type="checkbox"/>
Duwbeugel, in hoogte verstelbaar en afneembaar	Hoofdsteun, in hoogte verstelbaar en afneembaar (Maat A aangeven)	Duwbeugel en Hoofdsteun verstelbaar en afneembaar
€ 266	€ 266	€ 506
Art : 100 - 210 x x	Art : 100 - 230 x x	art.100-216 xx

<input type="checkbox"/> 1 Stuk 	<input type="checkbox"/> 2 Stuks 	<input type="checkbox"/> 1 Stuk 	<input type="checkbox"/> 2 Stuks 
Lumbaalband, 50mm breed <i>Los bijgeleverd</i>	Lumbaalband, 100mm breed <i>Los bijgeleverd</i>	Lumbaalband, 50mm breed <i>Los bijgeleverd</i>	Lumbaalband, 100mm breed <i>Los bijgeleverd</i>
€ 80	€ 160	€ 80	€ 160
Art : 100 - 46001	Art : 100 - 46002	Art : 100 - 46011	Art : 100 - 46012

<input type="checkbox"/> 	<input type="checkbox"/> 
Incontinentie hoes	Extra zittinghoes
€ 133	€ 133
Art : 100 - 112 x x	Art : 100 - 111 x x

<input type="checkbox"/>	<input type="checkbox"/>	<input type="checkbox"/>
		
Kuitband	Positioneringsgordel	Tasje onder de zitting
€ 38	€ 102	€ 91
Art : 800 - 01001	Art : 800-01002	Art : 800 - 01010

Het formulier s.v.p. volledig invullen en faxen naar. : +31 (0) 315 396 909 of mailen naar [info@o4wheelchairs.com](mailto:info@o4wheelchairs.com)

 Wheelchairs