



(Art : 260 - 000 x x)

Status

<input type="checkbox"/> Quote	<input type="checkbox"/> Order

Date	
------	--

Dealer information

Name	
Street	
Postal code/ City	
Contact person	
E-mail	
Phone	
Fax	

Shipping information

Name	
Street	
Postal code/ City	
Contact person	

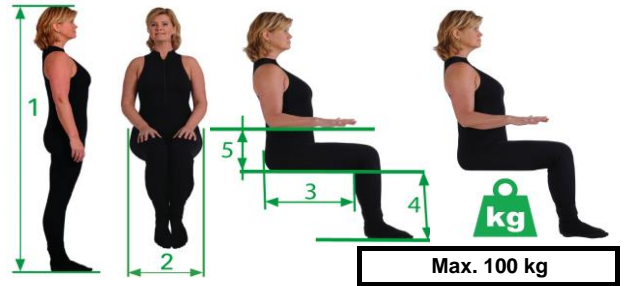

User information

Name	
Age	
Weight	
1) Standing height - cm	
2) Hip width sitting - cm	
3) Upper leg length - cm	
4) Lower leg length - cm	
5) Elbow height - cm	

Mandatory information to ensure correct configuration

Required settings

Front seat height (F) - cm		Standard = 53
Back seat height (G) - cm		Standard = 49
Wheelbalance (W) - cm		Standard = 7

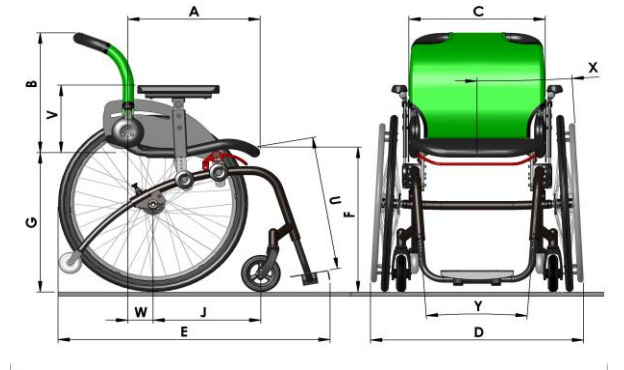

Comments

Fixed frame ==> On request

Baseprice	€	2.305
------------------	----------	--------------

Ex. VAT

Information of the wheelchair

Adjustments



Additional cost options	€
Additional cost adjustments	€

Price Exclusive VAT	€
----------------------------	---

Packaging and transport	€
--------------------------------	---





All our deliveries are subject to the General Conditions for the Supply of Mechanical, Electrical and Electronic Products (Orgalime S2000) as published by the Orgalime, The European Engineering Industries Association. Order form January 2014 (Specifications are subject to change without notice)

O4 Wheelchairs Markenweg 9, 7051 HS Varsseveld, Nederland T: +31 (0) 315 396 900 F: +31 (0) 315 396 909 E: info@o4.eu I: www.o4.eu

Seat width

<input type="checkbox"/> 29cm	<input type="checkbox"/> 31,5cm	<input type="checkbox"/> 34cm	<input type="checkbox"/> 36,5cm	<input type="checkbox"/> 39cm	<input type="checkbox"/> 41,5cm	<input type="checkbox"/> 44cm	<input type="checkbox"/> 46,5cm	<input type="checkbox"/> 49cm	<input type="checkbox"/> 51,5cm
Standard	Standard	Standard	Standard	Standard	Standard	Standard	Standard	Standard	Standard
Art : 800-40129	Art : 800-40131	Art : 800-40134	Art : 800-40136	Art : 800-40139	Art : 800-40141	Art : 800-40144	Art : 800-40146	Art : 800-40149	Art : 800-40151

Frame shape (Y)

<input type="checkbox"/>	<input type="checkbox"/>	<input type="checkbox"/>	<input type="checkbox"/>
			
U-Shape	V8	V16	Abduced-Shape
Standard	€ 172	€ 172	€ 372
Footspace = seat width - 10cm	Available from seat width 39cm Footspace = seat width - 15 cm	Available from seat width 44cm Footspace = seat width - 20cm	Footspace = seat width + 5cm
Art : 800-40210	Art : 800-40220	Art : 800-40230	Art : 800-40200

Frame length (J)

<input type="checkbox"/> 34cm	<input type="checkbox"/> 40cm	<input type="checkbox"/> 45cm
Recommended seat depth 37,5 - 42,5cm	Recommended seat depth 42,5 - 50cm	Recommended seat depth 45 - 50cm
Art : 800-40034	Art : 800-40040	Art : 800-40045





Frame Colour

<input type="checkbox"/> Anthracite	<input type="checkbox"/> White RAL 9016	<input type="checkbox"/> Blue RAL 5002	<input type="checkbox"/> Black RAL 9005	<input type="checkbox"/> Red RAL 3003	Special - Uni	Special Metallic
Standard	Standard	Standard	Standard	Standard	€ 90	On request
					Always refer to desired RAL colour through www.ralikleuren.com	
Art : 800-40310	Art : 800-40330	Art : 800-40335	Art : 800-40340	Art : 800-40340	Art : 800-40350	Art : 800-40300



Camber (X)

<input type="checkbox"/> 0°	<input type="checkbox"/> 3°	<input type="checkbox"/> 6°	<input type="checkbox"/> 9°
Standard	Standard	100,-	€ 172,-
Art : 800-40400	Art : 800-40403	Art : 800-40406	Art : 800-40409

Footrest

Lower leg length adjustment range (at lowest seat height front at 47 cm with 24 inch wheels)			
<input type="checkbox"/>	<input type="checkbox"/>	<input type="checkbox"/>	
			
Curved	Rectangular	Foldable 1 piece	
Lower leg length 39 - 44 cm	Lower leg length 33 - 38 cm	Lower leg length 33 - 44 cm	
		Foot space : minimum 24 cm U-vorm : at seat width 39 cm V8 : from seat width 44 cm Maximum user weight 80 kg	
Standard	Standard	€ 218	
Art : 200 - 38100	Art : 200 - 38200	Art : 200 - 38300	





Footplate

<input type="checkbox"/>	<input type="checkbox"/>	<input type="checkbox"/>	<input type="checkbox"/>	<input type="checkbox"/>
			Custom made	Custom made
Standard (23 x 12cm) Aluminum	Wide (29 x 12cm) Aluminum	Deep (23 x 19cm) Aluminum	Aluminum	Plastic
	U-shape: from seat width 39cm V8 : from seat width 44 cm		commissioned after drawing	
Standard	€ 68	€ 68	On request	
Art : 800 - 38009	Art : 800 - 38010	Art : 800 - 38040	Art : 800 - 3801 x	Art : 800 - 3802 x



Seat depth

<input type="checkbox"/> 35cm	<input type="checkbox"/> 37,5cm	<input type="checkbox"/> 40cm	<input type="checkbox"/> 42,5cm	<input type="checkbox"/> 45cm	<input type="checkbox"/> 47,5cm	<input type="checkbox"/> 50cm
Only in combination with RCA 1.0						Not in combination with RCA1.5
Art : 800-40535	Art : 800-40537	Art : 800-40540	Art : 800-40542	Art : 800-40545	Art : 800-40547	Art : 800-40550



Seating

<input type="checkbox"/>	<input type="checkbox"/>	<input type="checkbox"/>	<input type="checkbox"/>
			
Flat seat, harness, Cordura, for inlaycushion	Flat seat, expended metal, not in combination with RCA 1.0. For inlaycushion	Seating flat with Seat-E-Lastica; not in combination with RCA 1.0	Ergonomic contour seat cushion, padded
Standard	€ 527	€ 290	€ 482
Art : 100-140 x x	Art : 100-143 x x	Art : 100-142 x x	Art : 100-122 x x

Cushion





<input type="checkbox"/>	<input type="checkbox"/>	<input type="checkbox"/>
		Custom made
Cushion medium	Cushion Soft	Commissioned after drawing
6cm foam	3cm latex (upper layer) 2cm foam (lower layer)	
€ 94	€ 165	On request
Art : 100-412 x x	Art : 100-411 x x	Art : 100-413 x x

Backrest hinge





<input type="checkbox"/>	<input type="checkbox"/>	<input type="checkbox"/>
		
Basic	RCA 1.0	RCA 1.5
Back Foldable back angle mechanically adjustable (adjustment range 85 to 115 °)	Backrest-hinge centered	Backrest-hinge 2,5 cm rearpositioned
Standard	By user manually per 3 ° adjustable (adjustment range 0 - 85 to 115 °) RCA = Remote Continuous Adjustable	Standard
€ 380	€ 432	€ 497
Art : 100-38000	Art : 100-32000	Art : 100-36000

<input type="checkbox"/>

Reinforced RCA 1.0 (spasm)
Backrest-hinge centered
On request
Art : 100-32000



Backrest shape

<input type="checkbox"/>	<input type="checkbox"/>	<input type="checkbox"/>	<input type="checkbox"/>
			
Straight	Ergonomic, anatomic backrest height from 40cm	Backrest for women, ergonomic, anatomic backrest height from 40cm	Backrest shape 'Delta', only with seating width 39cm/41,5cm/44cm
Standard	€ 393	€ 495	€ 495
Art : 100-225 x x	Art : 100-200 x x	Art : 100-220 x x	Art : 100 - 240 x x







Backrest height

<input type="checkbox"/>	<input type="checkbox"/>	<input type="checkbox"/>	<input type="checkbox"/>
			
Height 35cm	Height 40cm	Height 45cm	Height 50cm
Art : 800-42135	Art : 800-42140	Art : 800-42145	Art : 800-42150

Backrest height Delta Backrest

<input type="checkbox"/>	<input type="checkbox"/>
	
Height 60cm	Height 70cm
Art : 800-42160D	Art : 800-42170D

Backrest cover Colour





<input type="checkbox"/>	<input type="checkbox"/>	<input type="checkbox"/>	<input type="checkbox"/>	<input type="checkbox"/>	<input type="checkbox"/>	<input type="checkbox"/>
						Spare cover
Orange	Red	Black	Blue	Dark Blue	Silver	Colour:
Standard	Standard	Standard	Standard	Standard	Standard	€ 91
Art : 100-400 x x	Art : 100-401 x x	Art : 100-402 x x	Art : 100-403 x x	Art : 100-405 x x	Art : 100-406 x x	Art : 100-400 x x

Wheel diameter

Possible seat height technical measure sheet

<input type="checkbox"/> 22" x 1 - (25 - 489)	<input type="checkbox"/> 24" x 1 - (25 - 540)	<input type="checkbox"/> 25"	<input type="checkbox"/> 26" x 1 - (25 - 590)	<input type="checkbox"/> 28"
€ 76	Standard	€ 102	€ 102	€ 102
Marathon Plus Evolution tyres				
Only in combination with 4 inch castors				
Art : 800-41022	Art : 800-41024	Art : 800-41025	Art : 800-41026	Art : 800-41028

Rear wheel (set, with Quick Release)

<input type="checkbox"/> 	<input type="checkbox"/> 	<input type="checkbox"/> 	<input type="checkbox"/> 
	Rear wheel with drumbrake (with black rim) only in 24", push handle recommended	Rearwheel with Edco hub-lock	Reinforced
Standard	€ 1.018	€ 190	€ 356,40
Art : 800-41024	Art : 991 - 42 x x x	Art : 991 - 2 x 101	Art : 991 - 2 X 202







Lightweight

<input type="checkbox"/>	<input type="checkbox"/>	<input type="checkbox"/>
Lightweight Spinergy-wheels	Lightweight Tensio-wheels	Heavy Duty Tensio wheels
Set	Set	Set
On request	On request	On request
Art : 991 - 43 x x x	Art : 991 - 455 0 x	Art : 991 - 455 1 x

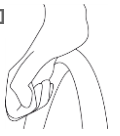

Rear tire

<input type="checkbox"/> 	<input type="checkbox"/> 	<input type="checkbox"/> 	<input type="checkbox"/> 	<input type="checkbox"/> 
Schwalbe Marathon Plus Evolution	Solid - PU	Schwalbe Right Run Red	Schwalbe Right Run Blue	Schwalbe Right Run Grey
Standard	€ 85	€ 0	€ 0	€ 0
Art : 991-67 x 01	Art : 991-67 x 11	Art : 991-67 X 21	Art : 991-67 X 22	Art : 991-67 X 23





Handrim (set)

<input type="checkbox"/> 	<input type="checkbox"/> 	<input type="checkbox"/> 	<input type="checkbox"/> 	<input type="checkbox"/> 	<input type="checkbox"/> 	<input type="checkbox"/> 	Handrim distance to wheelrim	
Aluminum	TETRA	PARA	ERGO	Stainless steel	Handrimcover (1 piece)	Handrimcover (1 piece)	<input type="checkbox"/> Narrow	<input type="checkbox"/> Wide
Standard	€ 430	€ 430	€ 468	€ 245	€ 88	€ 88	Standard	Option without costs
	Handrim with extra gripp	Handrim with extra gripp	Handrim with extra gripp					
Art : 800-62x11	Art : 800-62x01	Art : 800-62x02	Art : 800-62x03	Art : 800-62x12	Art : 991-61x01	Art : 991-61x01	-	-

Spoke guard (set)

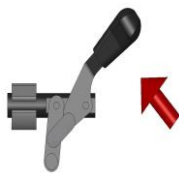
<input type="checkbox"/> 	<input type="checkbox"/> 
Transparant	O4-logo
€ 120	€ 100
Art : 991 - 60 x 01	Art : 991 - 60 x 02



Wheel lock





<input type="checkbox"/> Left <input type="checkbox"/> Right 		<input type="checkbox"/> Left <input type="checkbox"/> Right 		<input type="checkbox"/> Left <input type="checkbox"/> Right 		<input type="checkbox"/> Left <input type="checkbox"/> Right 	
Pull lock (pull to lock)		Push lock (push to lock)		S-lock - only in combination with seat depth 40-42,5-45cm		Active lock	
Standard		Standard		€ 58	€ 58	€ 139	€ 139
Art : 800-47103	Art : 800-47203	Art : 800-47104	Art : 800-47204	Art : 800-47102	Art : 800-47202	Art : 800-47106	Art : 800-47206





<input type="checkbox"/> Left <input type="checkbox"/> Right 	
Long push lock, folding (push to lock)	
€ 58	€ 58
Art : 800 - 07105	Art : 800 - 07205

Castor wheels (Set)





For possible seating heights, we refer to our technical measuring sheet

<input type="checkbox"/> 	<input type="checkbox"/> 
Soft 6" Synthetic (only to be combined with 28" rear wheels)	Super Soft 6" Synthetic with wide running surface (only to be combined with 28" rear wheels)
€ 22	€ 296
Art : 800 - 06001	Art : 800 - 06004





<input type="checkbox"/> 	<input type="checkbox"/> 	<input type="checkbox"/> 	<input type="checkbox"/> 
Soft 5" Synthetic	Hard 5" Synthetic	Hard 5" Aluminum	Super Soft 5" Synthetic with wide running surface
Standard	€ 15	€ 115	€ 260
Art : 800 - 05001	Art : 800 - 05002	Art : 800 - 05003	Art : 800 - 05004

<input type="checkbox"/> 	<input type="checkbox"/> 	<input type="checkbox"/> 	<input type="checkbox"/> 
Soft 4" Synthetic	Hard 4" Synthetic	Hard 4" Aluminum	Super Soft 4" Synthetic with wide running surface
€ 22	€ 25	€ 90	€ 260
Art : 800 - 04001	Art : 800 - 04002	Art : 800 - 04003	Art : 800 - 04004

Anti-tip





<input type="checkbox"/> Left <input type="checkbox"/> Right 		<input type="checkbox"/> Left <input type="checkbox"/> Right 		<input type="checkbox"/> Left <input type="checkbox"/> Right 		<input type="checkbox"/> Left <input type="checkbox"/> Right 		<input type="checkbox"/> Left <input type="checkbox"/> Right 	
Anti-tip height adjustable		Anti-tip - 360° revolving (one-sided fit)		Anti-tip swing-away (not with 28" wheels)		Tip-assist (step tube) - fixed (not in combination with 2 anti-tip wheels)		Crutch holder	
€ 128	€ 128	€ 184	€ 184	€ 184	€ 184	€ 82	€ 82	€ 78	€ 78
Art : 800 - 44000	Art : 800 - 45000	Art : 800-44010	Art : 800-45010	Art : 800-44020	Art : 800-45020	Art : 800-43000	Art : 800-43500	Art: 800-43010	Art : 800-43510

Side guard





<input type="checkbox"/> 	<input type="checkbox"/> 	<input type="checkbox"/> 	<input type="checkbox"/> 	<input type="checkbox"/> 
Sideguard, fixed, no fender Only in combination with seat 'Cordura' and backrest hinge 'Basic'	Side guard, removable, no fender Only in combination with armrests	Side guard, fixed without fender, aluminum	Side guard, fixed with fender, aluminum	Side guard, fixed with fender, carbon
€ 0,-	€ 96	€ 96	€ 204	€ 322
Art : 100 - 96070		Art : 100 - 96040	Art : 100 - 96050	Art : 100 - 96010





Arm rests

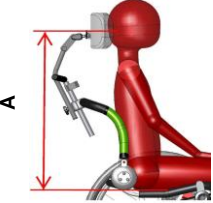

Arm cushioning (in combination with angle adjustable arm rest)





<input type="checkbox"/> 	<input type="checkbox"/> 	<input type="checkbox"/> 	<input type="checkbox"/> 	<input type="checkbox"/> Custom made	
In height adjustable armrest, removable, angle fixed. Only when combined with Side guard fixed with fender, only carbon, the side guard will be adjusted. (additional cost)	In height adjustable armrest, removable, angle adjustable Only when combined with Side guard fixed with fender, only carbon, the side guard will be adjusted. (additional cost)	Hemiplegic-arm cushioning (piece)	Arm cushioning long (piece) (Length as standard + 10cm)	commissioned after drawing	
€ 330	€ 420	€ 205	€ 205	€ 75	€ 75
Art : 100 - 96110	Art : 100 - 96170	Art : 100 - 96140	Art : 100 - 96240	Art : 100 - 96180	Art : 100 - 96280
				On request	On request
				Art : 100 - 96130	Art : 100 - 96230

Accessoires

<input type="checkbox"/> 	<input type="checkbox"/> 		<input type="checkbox"/> 	<input type="checkbox"/> 
Push handle, in height adjustable and removable	Headrest, in height adjustable and removable (Indicate measure A)		Rising support for the back (not mounted)	
€ 225	€ 237		€ 98	€ 196
Art : 100 - 210 x x	Art : 100 - 230 x x	A (cm) =	Art : 100 - 47010	Art : 100 - 47020

<input type="checkbox"/> 	<input type="checkbox"/> 	<input type="checkbox"/> 	<input type="checkbox"/> 
Sidepad small 10x12 cm possible from backheight 45 cm. <i>Not mounted</i>	Sidepad small 14x14 cm possible from backheight 45 cm. <i>Not mounted</i>	Tension strap for back, adjustable, out of Seat-E-Lastica, 5 cm wide <i>Not mounted</i>	Tension strap for back, adjustable, out of Seat-E-Lastica, 10 cm wide <i>Not mounted</i>
€ 288	€ 308	€ 62	€ 124
Art : 800-01102	Art : 800-01202	Art : 800-01101	Art : 800-01201
		Art : 100 - 46001	Art : 100 - 46002
		Art : 100 - 46011	Art : 100 - 46012

<input type="checkbox"/> 	<input type="checkbox"/> 
Incontinence cover	Extra Seating cover
€ 103	€ 103
Art : 100 - 112 x x	Art : 100 - 111 x x

<input type="checkbox"/> 	<input type="checkbox"/> 	<input type="checkbox"/> 	<input type="checkbox"/> 
College-worktop	Safety belt	Calf band	Purse under the seat
On request	€ 92	€ 34	€ 84
Art : 800 - 01003	Art : 800-01002	Art : 800 - 01001	Art : 800-01010

The wheelchair is crashtest safe complies to ISO 7176-19 for transport in taxi, fixed seated in the wheelchair.

Fill out the form completely and send it to : +31 (0) 315 396 909 (fax) or mail to info@o4.eu

All our deliveries are subject to the General Conditions for the Supply of Mechanical, Electrical and Electronic Products (Orgalime S2000) as published by the Orgalime, The European Engineering Industries Association. Order form January 2014 (Specifications are subject to change without notice)

Wheelchairs T: +31 (0) 315 396 900 Markenweg 9, 7051 HS Varsseveld, Netherlands F: +31 (0) 315 396 909 E: info@o4.eu I: www.o4.eu